

DRAIN COUPLING

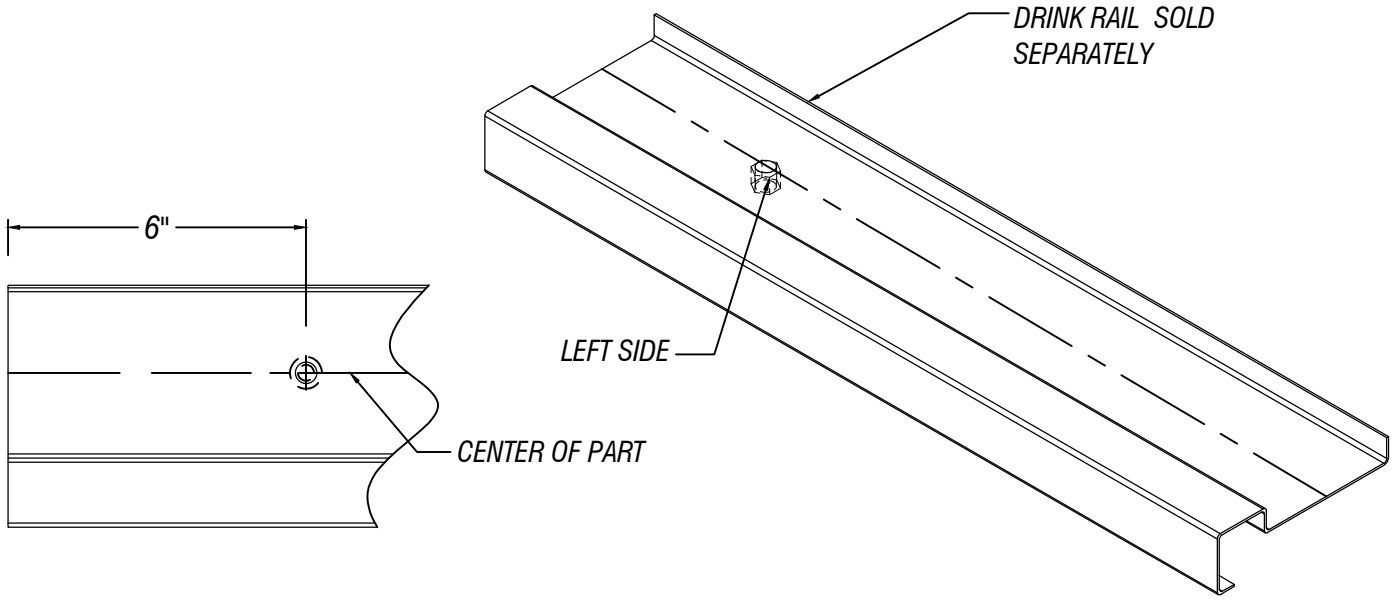

TOP VIEW

ISOMETRIC VIEW

#4 BRUSHED FINISH = *

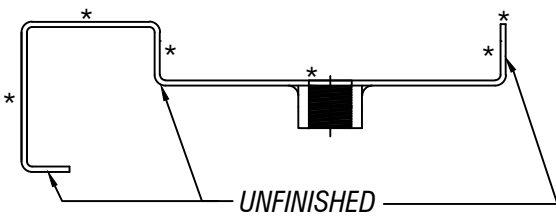

SQUARE PROFILE SHOWN FOR ILLUSTRATION PURPOSES ONLY

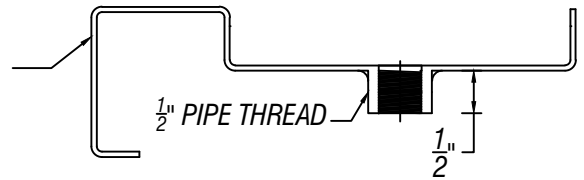

FINISH DETAIL

SIDE VIEW

PART #	FINISH SCHEDULE	DRAWN: GV
DR-DC-1	SATIN STAINLESS STEEL #304 ALLOY	CHECKED: RD
		DATE: 01/27/2020

