

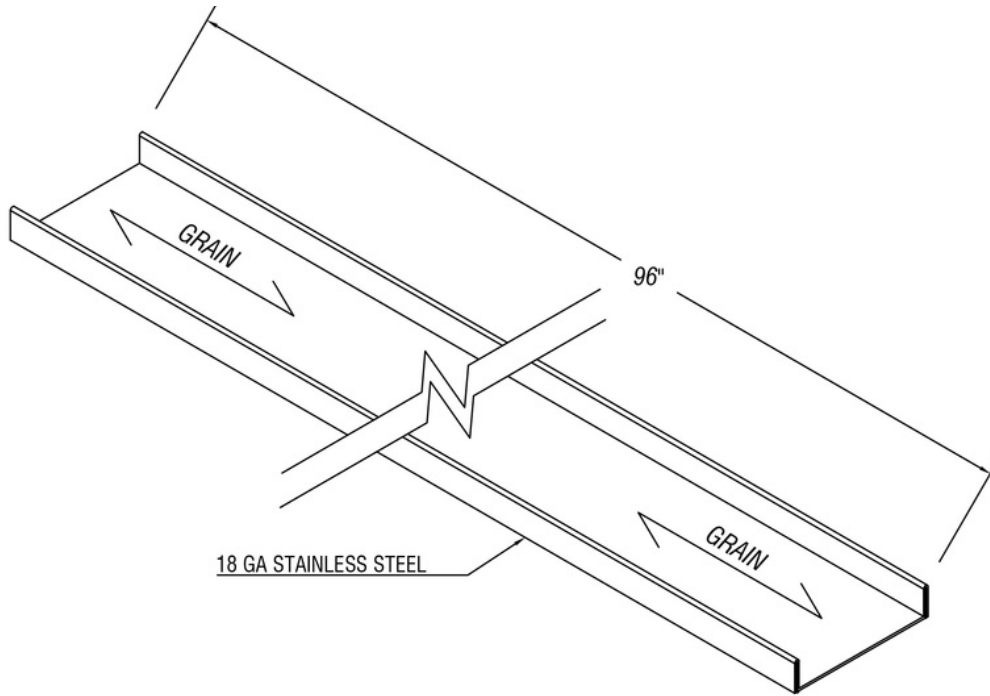

ARCH HARDWARE

TABLE MOUNT SCUPPER 3 7/8 " OVERALL



ISOMETRIC VIEW



FINISH SCHEDULE

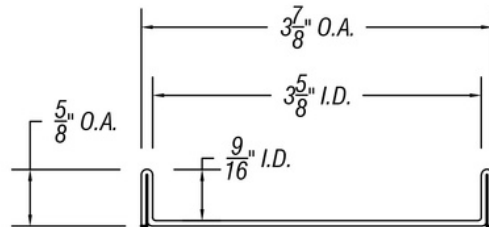

SIDE VIEW

* = FINISH SIDES

↕ = GRAIN DIRECTION

PART #	MATERIAL	FINISH
DR462-378	18 Ga. Stainless Steel #304 alloy	Satin (#4 Brush)



Phone
(800)-679-2614



Email
webstore@archhardware.net



Address
303 Maler Rd., Sealy, TX 77474